

# E900 EURO

Standard escutcheon Outside Euro Profile / Inside blind

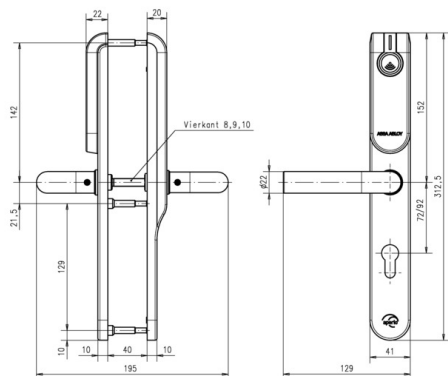









## Product description

- Access decision is made by the AAperio® escutcheon based on access data on card - access data are written on card via EAC system updater
- Can be used with all European (DIN) mortise locks - in wooden, steel and tubular-frame doors
- Main electronics (RFID + radio) outside - security-relevant electronics inside
- Outside handle rotates freely - inside handle always engaged
- LED for status visualisation

## Scope of delivery

- 1 escutcheon with battery (Lithium CR123A) and installation instructions
- Screws, drilling template and tool (for inserting cables)

## Technical data - Standard escutcheon

	<b>Approvals</b>	CE
	<b>Dimension</b>	312 x 41 x 10/20 mm (H x W x D)
	<b>Handle</b>	L-Shape, U-Shape
	<b>Version</b>	Basic = internal doors to category 2
	<b>Surface</b>	Stainless steel brushed (ST)
	<b>Distance</b>	Distance 72 mm, 85 mm, 92 mm; Spindle 8 mm, 9 mm, 10 mm
	<b>Door leaf thickness</b>	Door leaf between 40 and 100 mm thick, in 10 mm increments
	<b>Backset</b>	> 40 mm
	<b>Battery</b>	1 x Lithium CR123A
	<b>Battery life</b>	30 openings per day for 49 months
	<b>Radio standard</b>	IEEE 802.15.4 (2.4 GHz)
	<b>Encryption (radio communication)</b>	AES 128 bits
	<b>Class of protection</b>	IP 52
	<b>Operating temperature range</b>	0°C to 60°C
	<b>Relative humidity</b>	< 85% (condensation-free)
	<b>Status</b>	LED (red/green/orange)
	<b>RFID Technologies (Based on reader type)</b>	MIFARE Classic® / MIFARE® DESFire® EV1
	<b>RFID reading</b>	UID / Sektor / Block / Application / File
	<b>RFID Reading range</b>	< 4 cm
	<b>OSS Standard Offline</b>	Optional available (MIFARE® DESFire®, LEGIC® Advant)